

# 듀라카브 금형 Solution

## APMT 1135 PDER

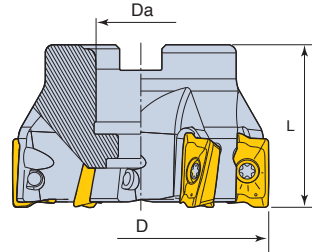
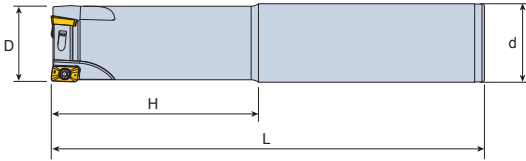
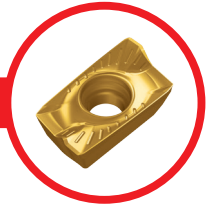

규격		치수(mm)		
		D	d	H
90E1616-APM11-L85	2	16	16	25
90E2020-APM11-L150	2	20	20	60
90E2525-APM11-L170	3	25	25	70
90E3232-APM11-L190	3	32	32	90
90E4032-APM11-L190	3	40	32	90

규격		치수(mm)		
		D	Da	L
90F-D50-22-APM11	4	50	22	40
90F-D63-22-APM11	5	63	22	40
90F-D80-25.4-APM11	6	80	25.4	50

## APMT 1604 PDER

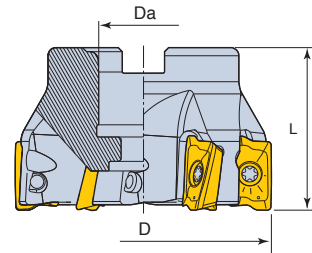
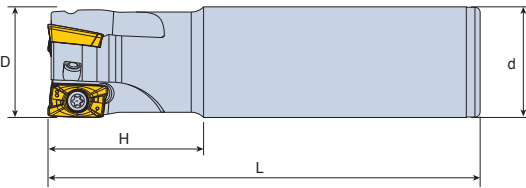
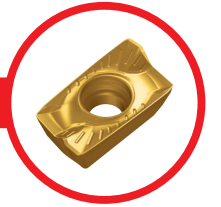

규격		치수(mm)		
		D	d	H
90E2525-APM16-L115	2	25	25	35
90E3232-APM16-L125	3	32	32	45
90E4032-APM16-L125	4	40	32	45

규격		치수(mm)		
		D	Da	L
90F-D50-22-APM16	4	50	22	40
90F-D63-22-APM16	5	63	22	40
90F-D80-25.4-APM16	6	80	25.4	50

## RPMW 1003 MO

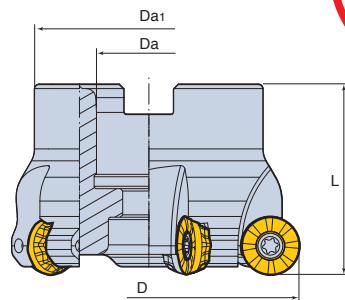
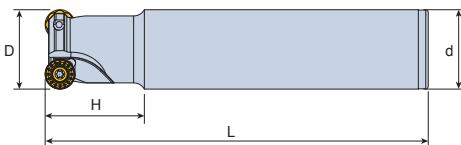

규격		치수(mm)		
		D	d	H
ERP02020-10-L180	2	20	20	30
ERP02525-10-L180	2	25	25	30

규격		치수(mm)			
		D	L	Da1	Da
FRP-D40-16-10	4	40	40	38	16
FRP-D50-22-10	5	50	50	45	22

# 듀라카브 금형 Solution

## RPMT 1204 M-C

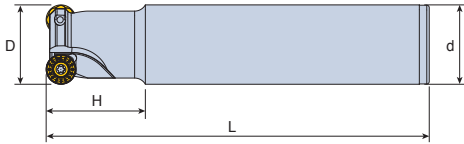

규격		치수(mm)		
		D	d	H
ERP03232-12-L200	2	32	32	40
ERP04032-12-L200	3	40	32	40

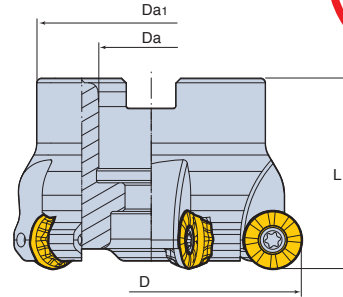

규격		치수(mm)			
		D	L	Da1	Da
FRP-D50-22-12	4	50	50	45	22
FRP-D63-22-12	5	63	50	45	22

## RPMT/W



RPMT 10T3 MO DP5320  
1204-M-C DP5320  
RPMW 1003 MO DP5320

## APMT

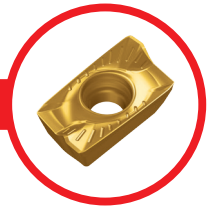

APMT 1135 PDER DP5320  
1604 PDER DP5320

적용 Grade : DP5320

합금강, 스텐인레스강, 내열 합금강 가공에 적합 합니다.

적용 영역

**P20 - P40**

**M20 - M40**

**S20 - S40**